

REV	Description	Date
A00	First Issue	2002-DEC-25

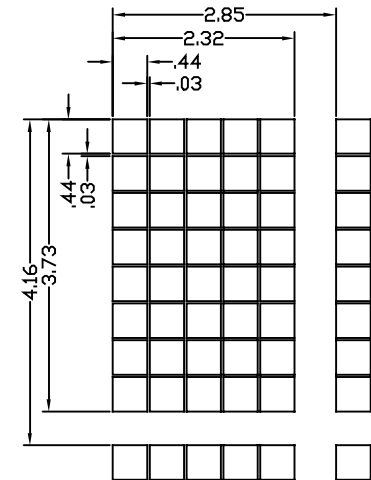

Character Dot Pattern

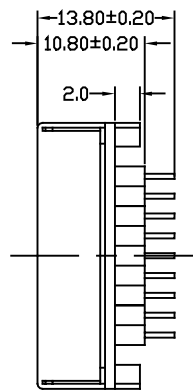
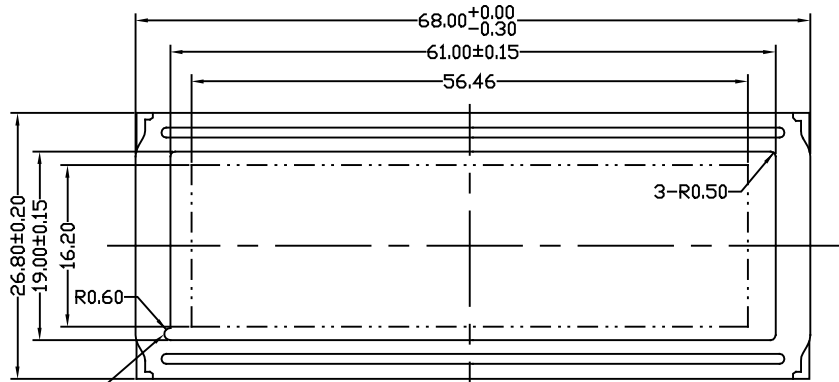
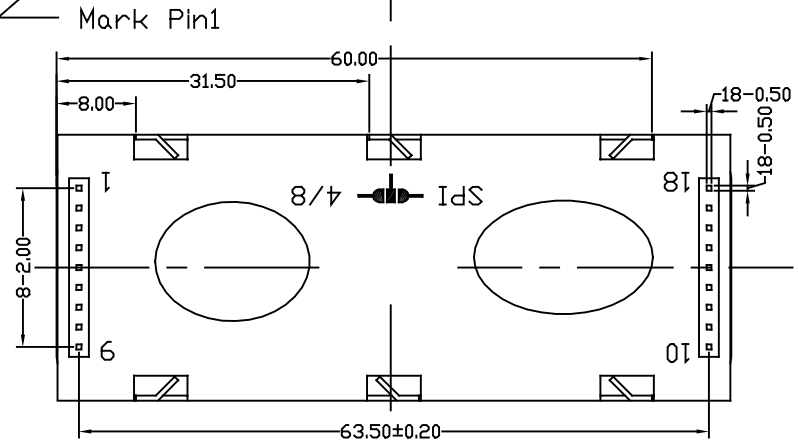

With Led

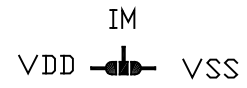

- Pinout:
- |             |                             |
|-------------|-----------------------------|
| 1 VSS       | 10 D3                       |
| 2 VDD       | 11 D4                       |
| 3 VEE       | 12 D5                       |
| 4 RS (CS)   | 13 D6                       |
| 5 R/W (SID) | 14 D7                       |
| 6 E (SCLK)  | 15 NC                       |
| 7 Do (SDD)  | 16 RESET (INTERNAL PULL-UP) |
| 8 D1        | 17 A                        |
| 9 D2        | 18 C                        |

Controller: Samsung S6A0073 or equivalence

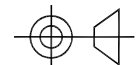
Description: <b>MECHANICAL SPECIFICATIONS</b>	
Scale:	 <b>TRI-T COMPANY LIMITED</b>
Sheet : 1 of 1	
Unspecified Tol. ±0.3	Unit mm
Approvals	Date
Draw:	Project Number
Check:	TMBC20433B-XX
Approve:	Item Number
Do Not Scale This Drawing	
 Projection	