

HBGQ Signal Lamp dot illuminated mounting hole : $\Phi 8$

Order Code - Configurazione di un modello

Configura un pulsante o un interruttore facendo uso della seguente simbologia :

Materiale The crust material	Contatti Contact configuration	Modalità di funzionamento Operation type	Selezione Operation position of selector and Key-Lock switch	Colore Led color	Volt Led Led voltage	Grado IP Protective Degree
N : Nichel-plated Brass G : Gold-plated Brass S : Stainless Steel A : Zn-al Alloy Black T : Zn-al Alloy Silver W	11 : 1NO 1NC 22 : 2NO 2NC	D : indicator light Z : self-lock button Y : key button X : select button TS : push lock screw button The momentary type is without letter	Indicate selector and Key-lock Position 2: two position 3: three position --- 1 :maintained 2 : reset at right 3 :reset at left 4 : full reset	R Red G Green Y Yellow O Orange B Blue W White	6 12 24 110 220	IP40 (IP67)* * Su richiesta * On demand

Description - Descrizione	Figura
Diagramm each single contact Schema elettrico (singolo contatto) Se doppio, il contatto è ripetuto	
Symbol Simbolo	
Nota : Diagramm is referred for one single contact Riferito ad ogni singolo contatto	Can be configured two sets of switches: C1 and C2 (C1 = 11 1NCNO C2 = 22 2NONC) . +/- pins are led terminals Possono essere configurati due serie di contatti C1 singolo e C2 doppio : (C1 = 11 1NONC C2 = 22 2NONC) I terminali +/- appartengono al diodo led.

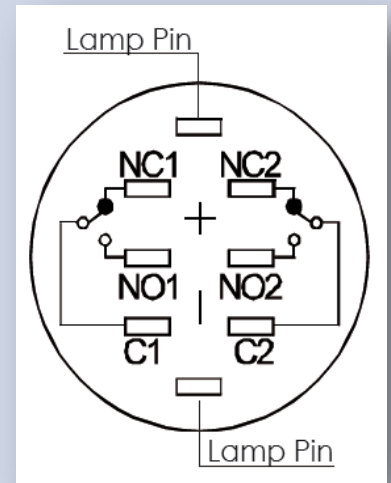

LampType	LED lamp(AC/DC)			Lamp Circuit Diagram
LEDColor				
Life	40000hours(Reference)			
RatedVoltage	AC/DC6V	AC/DC12V	AC/DC110V	
	AC/DC24V	AC/DC36V	AC/DC220V	
RatedCurrent	About15mA		About3mA	
Dropping Way	Innerresistance		Outerresistance when using6Vlamp	

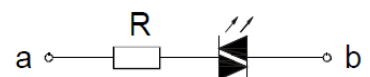

Using AC/DC led lamp. Terminals have no difference of anode and cathode.
 Non c'è differenza di polarità ai terminali del led. Collegando una resistenza esterna si può adattare il funzionamento del led ad una tensione superiore : ad esempio il led interno è di 5V. Con una resistenza esterna da 1K il led può funzionare a 12V.

HBGQ8 Lamp Series mounting hole : $\Phi 12$



HBGQ8C

HBGQ8F

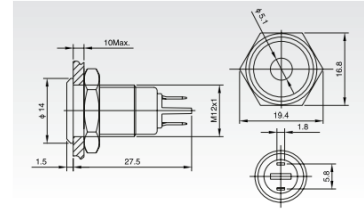
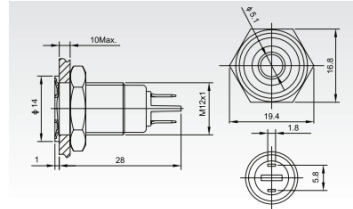

HBGQ12FDJ

HBGQ12FDS

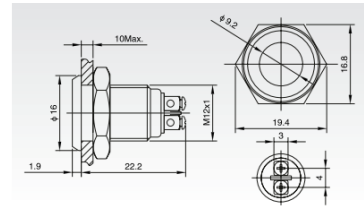
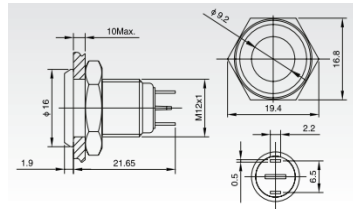

Esempio d' ordine

HBGQ8CDNR12

Lampada di segnalazione led dot ROSSO 12V terminale a saldare Nickel Plated

HBGQ8CDNG24

Lampada di segnalazione led dot VERDE 24V terminale a saldare Nickel Plated

HBGQ12FDJW12N

Lampada di segnalazione led flat BIANCO 12V terminale a saldare Nickel Plated

HBGQ12FDSY220S

Lampada di segnalazione led flat GIALLO 220V terminale a vite Stainless Steel

Installation effect preview



HBGQ8 Lamp Series mounting hole : Φ 8mm



HBGQ8C-D/N ▲ ▲

- Mounting hole size : 8 mm
- Rated current: ~15mA
- Lamp color : R/G/Y/O/B/W
- Connector : pin terminal
- Operation temperature : -20°C ~ +55°C
- The crust material : Nickel-plated Brass
- Protection degree : IP67 IK10

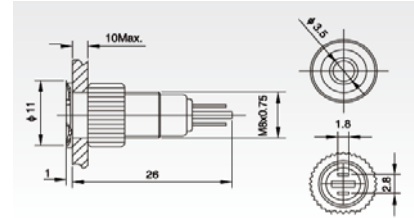

HBGQ8F-D/N ▲ ▲

- Mounting hole size : 8 mm
- Rated current: ~15mA
- Lamp color : R/G/Y/O/B/W
- Connector : pin terminal
- Operation temperature : -20°C ~ +55°C
- The crust material : Nickel-plated Brass
- Protection degree : IP67 IK10

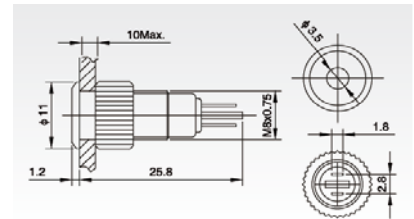

▲ ▲ = Colore / tensione

HBGQ8	HBGQ8C-D/N ▲ ▲	HBGQ8F-D/N ▲ ▲	
Terminal Type	Pin Terminal (1,8 x 0.4mm)	Pin Terminal (1,8 x 0.4mm)	
Dielectric Strength (VAC)	1100	1100	
Operating Temperature	-20°C ~ +55°C	-20°C ~ +55°C	
Panel Thickness (mm)	1 ~ 5	1 ~ 5	
Torque (Nm)	5 ~ 14	5 ~ 14	
Protection Degree	IP67 (IK10)	IP40 (IK10)	
Electrical Life (hours)	> 200.000	> 200.000	
Panel Thickness (mm)	1 ~ 5	1 ~ 5	
Torque (Nm)	5 ~ 14	5 ~ 14	
Shade	PC	PC	
Case	Nickel-plated Brass	Nickel-plated Brass	
Base	PBT	PBT	
Rated Voltage Lamp (V)	2/6/12/24/36 110/220	2/6/12/24/36 110/220	
Rated Current (mA)	~15 ~3 (110/220V)	~15 ~3 (110/220V)	
Color	R G Y O B W	R G Y O B W	

HBGQ12 Lamp Series mounting hole : Φ 12mm



HBGQ8C-D/J ▲ ▲ ⊙

- Mounting hole size : 12 mm
- Rated current: ~15mA
- Lamp color : R/G/Y/O/B/W
- Connector : pin terminal
- Operation temperature : -20°C ~ +55°C
- The crust material : NPB - SS
- Protection degree : IP67 IK10

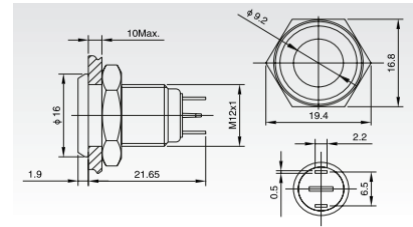

HBGQ8C-D/N ▲ ▲ ⊙

- Mounting hole size : 12 mm
- Rated current: ~15mA
- Lamp color : R/G/Y/O/B/W
- Connector : screw terminal
- Operation temperature : -20°C ~ +55°C
- The crust material : NPB - SS
- Protection degree : IP67 IK10

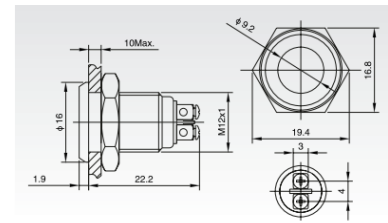







▲ ▲ = Colore / tensione
 ⊙ = tipo di materiale



HBGQ12	HBGQ12C-D/J ▲ ▲ ⊙	HBGQ12F-10A ▲ ▲ ⊙	
Terminal Type	Pin Terminal (1,8 x 0.4mm)	Screw Terminal (1,8 x 0.4mm)	
Dielectric Strength (VAC)	2000	2000	
Operating Temperature	-20°C ~ +55°C	-20°C ~ +55°C	
Panel Thickness (mm)	1 ~ 10	1 ~ 10	
Torque (Nm)	5 ~ 14	5 ~ 14	
Protection Degree	IP67 (IK10)	IP40 (IK10)	
Electrical Life (hours)	> 50.000	> 50.000	
Panel Thickness (mm)	1 ~ 5	1 ~ 5	
Torque (Nm)	5 ~ 14	5 ~ 14	
Shade	PC	PC	
Case	Stainless Steel - Nickel-plated Brass	Stainless Steel - Nickel-plated Brass	
Base	PBT	PBT	
Rated Voltage Lamp (V)	2/6/12/24/36 110/220	2/6/12/24/36 110/220	
Rated Current (mA)	~15 ~3 (110/220V)	~15 ~3 (110/220V)	
Color	R G Y O B W	R G Y O B W	

HBGQ12 Pushbuttons Series mounting hole : $\Phi 12$

Order Code - Configurazione di un modello

Configura un pulsante o un interruttore facendo uso della seguente simbologia :

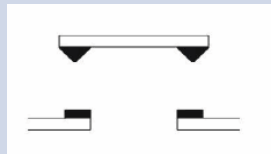
						
Materiale The crust material	Contatti Contact configuration	Modalità di funzionamento Operation type	Selezione Operation position of selector and Key-Lock switch	Colore Led color	Volt Led Led voltage	Grado IP Protective Degree
N : Nichel-plated Brass G : Gold-plated Brass S : Stainless Steel A : Zn-al Alloy Black T : Zn-al Alloy Silver W	11 : 1NO 1NC 22 : 2NO 2NC	D : indicator light Z : self-lock button Y : key button X : select button TS : push lock screw button The momentary type is without letter	Indicate selector and Key-lock Position 2 : two position 3 : three position --- 1 :maintained 2 : reset at right 3 :reset at left 4 : full reset	R Red G Green Y Yellow O Orange B Blue W White	6 12 24 110 220	IP40 (IP67)* * Su richiesta * On demand

Description - Descrizione	Figura
Diagramm each single contact Schema elettrico (singolo contatto) Se doppio, il contatto è ripetuto	
Symbol Simbolo	
Nota : Diagramm is referred for one single contact Riferito ad ogni singolo contatto	Can be configured two sets of switches: C1 and C2 (C1 = 11 1NCNO C2 = 22 2NONC) . +/- pins are led terminals Possono essere configurati due serie di contatti C1 singolo e C2 doppio : (C1 = 11 1NONC C2 = 22 2NONC) I terminali +/- appartengono al diodo led.

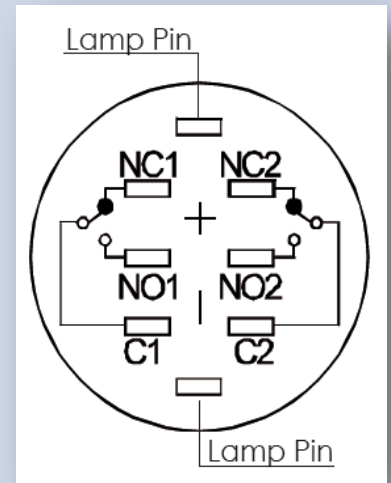

LampType	LED lamp(AC/DC)			Lamp Circuit Diagram
LEDColor				
Life	40000hours(Reference)			
RatedVoltage	AC/DC6V	AC/DC12V	AC/DC110V	
	AC/DC24V	AC/DC36V	AC/DC220V	
RatedCurrent	About15mA		About3mA	
Dropping Way	Innerresistance		Outerresistance when using6Vlamp	



Using AC/DC led lamp. Terminals have no difference of anode and cathode.
 Non c'è differenza di polarità ai terminali del led. Collegando una resistenza esterna si può adattare il funzionamento del led ad una tensione superiore : ad esempio il led interno è di 5V. Con una resistenza esterna da 1K il led può funzionare a 12V.

HBGQ12 Plastic Pushbuttons Series mounting hole : $\Phi 12$

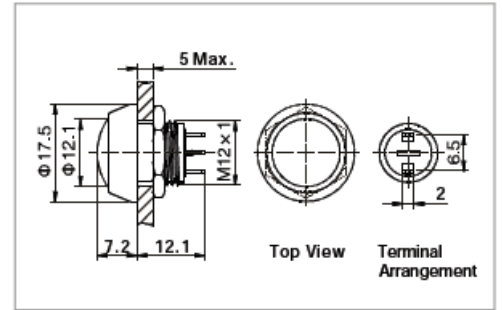
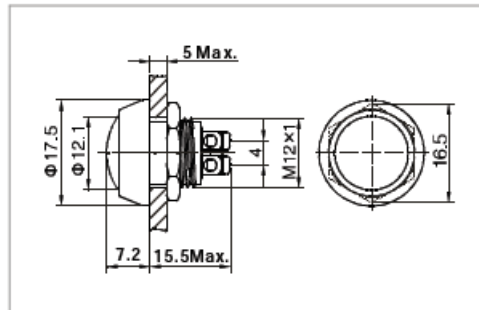

Shape and Dimensions

Esempio d' ordine

- HBGQ12B10AJB** Pulsante 12 mm colore BLU terminali a saldare
- HBGQ12B10AB** Pulsante 12 mm colore BLU terminali a vite
- HBGQ12F10EJY12** Pulsante 12mm tipo Flat, ring ROSSO terminali a saldare LED 12V
- HBGQ12H10EJG12** Pulsante 12mm tipo High Round, ring Verde Terminali a saldare LED 12V



HBGQ12B-10/J/A/★



HBGQ12B-10/A/★



HBGQ12F-10/J/◎



HBGQ12F-10E/J/△/▲/◎



HBGQ12H-10E/J/△/▲/◎



Installation effect preview



HBGQ12 Series mounting hole : Φ 12



HBGQ12B-10JA ▲



HBGQ12B-10A ▲



HBGQ12B-10J ◎

- Mounting hole size : 12mm
- Switch rating : 2A 36VDC
- Contact configuration : 1 x NO
- Operation type : Momentary
- The crust material : Plastic
- Protection degree : IP65



- Mounting hole size : 12mm
- Switch rating : 2A 36VDC
- Contact configuration : 1 x NO
- Operation type : Momentary
- The crust material : Plastic
- Protection degree : IP65

- Mounting hole size : 12mm
- Switch rating : 2A 36VDC
- Contact configuration : 1 x NO
- Operation type : Momentary
- The crust material : Nickel-plated brass *
- Protection degree : IP65

* Staines Steel

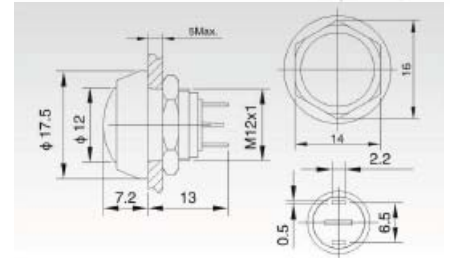
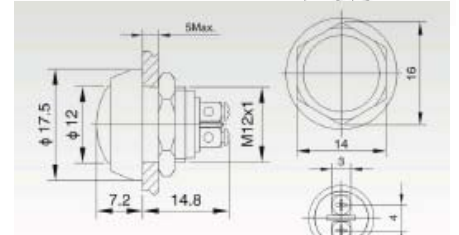
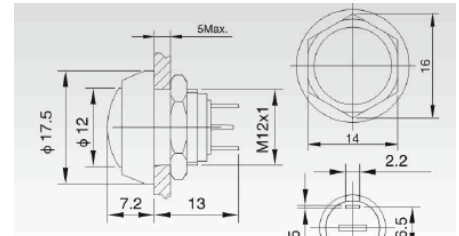

	HBGQ12B-10JA ▲	HBGQ12B-10A ▲	HBGQ12B-10J ◎
Terminal Type	Pin Terminal (2 x 0.5mm)	Screw Terminal	Pin Terminal (2 x 0.5mm)
Switch specifications	Ith: 2A / 36V	Ith: 2 A / 36V	Ith: 2A / 36V
Contact Resistance (mΩ)	≤ 50	≤ 50	≤ 50
Insulation Resistance (MΩ)	≥ 1000	≥ 1000	≥ 1000
Dielectric Strength (VAC)	2000	2000	2000
Operating Temperature	-20°C ~ +55°C	-20°C ~ +55°C	-20°C ~ +55°C
Mechanical Life (times)	> 1.000.000	> 1.000.000	> 1.000.000
Electrical Life (times)	> 200.000	> 200.000	> 200.000
Panel Thickness (mm)	1 ~ 5	1 ~ 5	1 ~ 10
Torque (Nm)	5 ~ 14	5 ~ 14	5 ~ 14
Operating Pressure (N)	about 5N	about 5N	about 4N
Protection Degree	IP65 (IK08)	IP40 (IK08)	IP65 (IK08)
Contact	Silver Alloy	Silver Alloy	Silver Alloy
Button	PBT	PBT	CD, Stainless ST. , CDpattern, Mirror Surface
Case	PBT	PBT	Nickel-Pl. Brass Stainless St.
Base	PBT	PBT	PBT
Rated Voltage Lamp (V)			
Color	R G Y O B W	R G Y O B W	

HBGQ12 Series mounting hole : $\Phi 12$



HBGQ12F-10J Ⓞ

- Mounting hole size : 12mm
- Switch rating : 2A 36VDC
- Contact configuration : 1 x NO
- Operation type : Momentary
- The crust material : Nickel plated or Stainless S.
- Protection degree : IP65

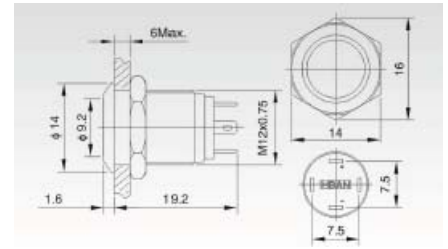

HBGQ12F-10EJ ▲▲Ⓞ

- Mounting hole size : 12mm
- Switch rating : 2A 36VDC
- Contact configuration : 1 x NO
- Operation type : Momentary
- The crust material : Nickel plated or Stainless S.
- Protection degree : IP65

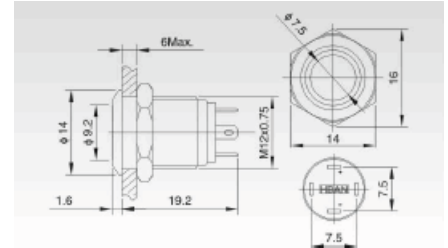

HBGQ12H-10EJ ▲▲Ⓞ

- Mounting hole size : 12mm
- Switch rating : 2A 36VDC
- Contact configuration : 1 x NO
- Operation type : Momentary
- The crust material : Nickel plated or Stainless S.
- Protection degree : IP65

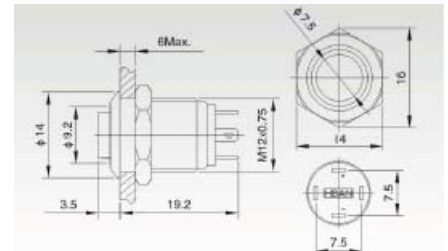

* Stainles Steel

	HBGQ12F-10J Ⓞ	HBGQ12F-10EJ ▲▲Ⓞ	HBGQ12H-10EJ ▲▲Ⓞ
Terminal Type	Pin Terminal (2 x 0.5mm)	Pin Terminal (2 x 0.5mm)	Pin Terminal (2 x 0.5mm)
Switch specifications	Ith: 2A / 36V	Ith: 2 A / 36V	Ith: 2A / 36V
Contact Resistance (mΩ)	≤ 50	≤ 50	≤ 50
Insulation Resistance (MΩ)	≥ 1000	≥ 1000	≥ 1000
Dielectric Strength (VAC)	2000	2000	2000
Operating Temperature	-20°C ~ +55°C	-20°C ~ +55°C	-20°C ~ +55°C
Mechanical Life (times)	> 1.000.000	> 1.000.000	> 1.000.000
Electrical Life (times)	> 200.000	> 200.000	> 200.000
Panel Thickness (mm)	1 ~ 5	1 ~ 5	1 ~ 10
Torque (Nm)	5 ~ 14	5 ~ 14	5 ~ 14
Operating Pressure (N)	about 5N	about 5N	about 4N
Protection Degree	IP65 (IK08)	IP40 (IK08)	IP65 (IK08)
Contact	Silver Alloy	Silver Alloy	Silver Alloy
Button	PBT	PBT	PBT
Case	PBT	PBT	Nickel-Pl. Brass Stainless St.
Base	PBT	PBT	PBT
Rated Voltage Lamp (V)		1,8/2,8/6/12/24/36 V	1,8/2,8/6/12/24/36 V
Color		R G Y O B W	R G Y O B W